

# LOS TEJIDOS VEGETALES

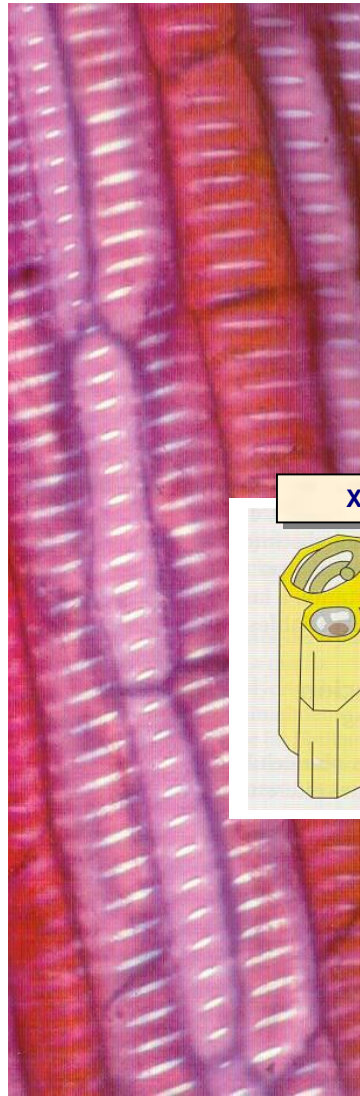

**Tejido epidérmico**

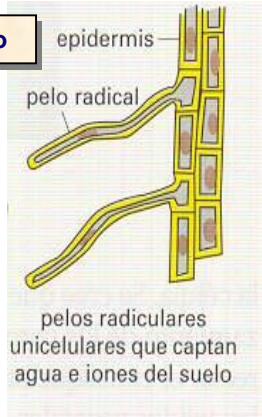
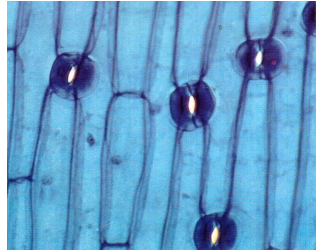

**Colénquima**

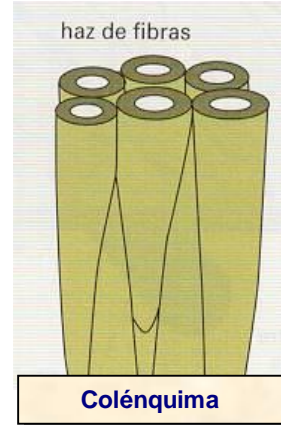

**Esclerénquima**

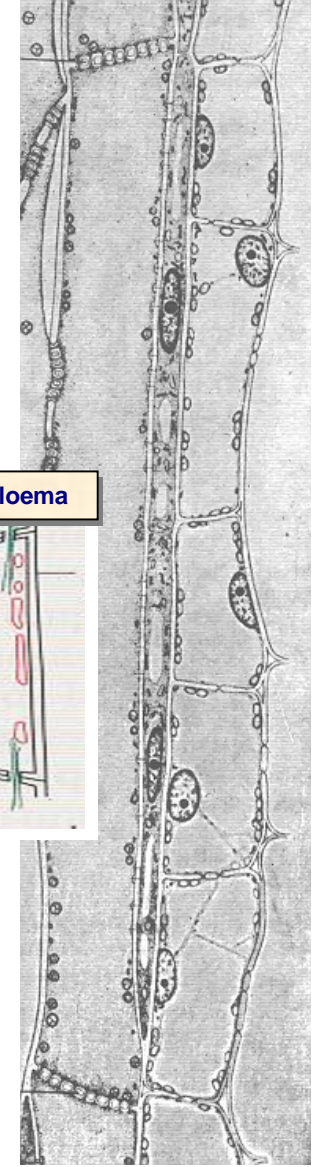
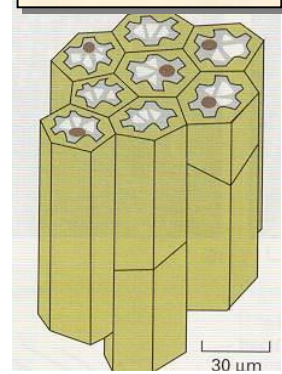

**Xilema**

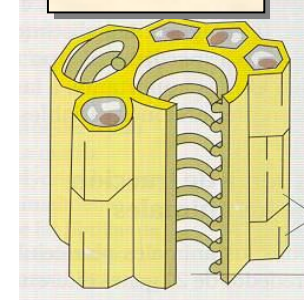

**Tejido meristemático**

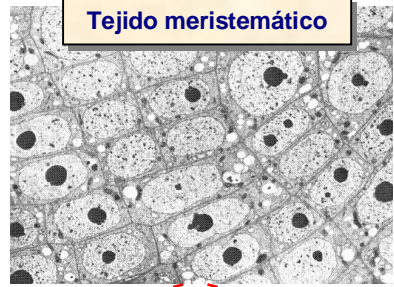

**Floema**

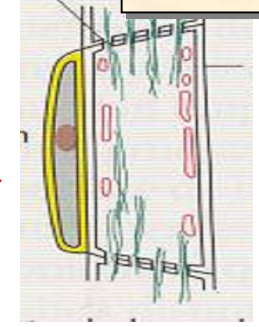

**Parénquima de reserva**



**Parénquima clorofílico**

